

NOTE: THIS IS A "RAINSCREEN" SYSTEM. THE BUILDING MUST BE WATERTIGHT PRIOR TO THE INSTALLATION OF THE PANEL SYSTEM.

DETAIL LEGEND

- | | | |
|-------------------------|--------------------------|--------------------------|
| 1- STANDARD PARAPET | 6A- OPTIONAL WINDOW HEAD | 11- INSIDE CORNER |
| 1A- OPTIONAL PARAPET | 7- STANDARD WINDOW SILL | 12- ROUND OUTSIDE CORNER |
| 2- HORIZONTAL JOINT | 7A- OPTIONAL WINDOW SILL | 13- ABUTMENT |
| 3- FEATURE BAND | 8- STANDARD WINDOW JAMB | 14- SQUARE COLUMN |
| 4- BASE CONDITION | 8A- OPTIONAL WINDOW JAMB | 15- CIRCULAR COLUMN |
| 5- WALL SOFFIT | 9- SQUARE OUTSIDE CORNER | |
| 6- STANDARD WINDOW HEAD | 10- VERTICAL JOINT | |

(T1) SL-2000P DETAIL LAYOUT



ADDING STRUCTURE TO VISION

WWW.SOBOTEC.COM PH: 905-578-1278

HAMILTON,
ONTARIO

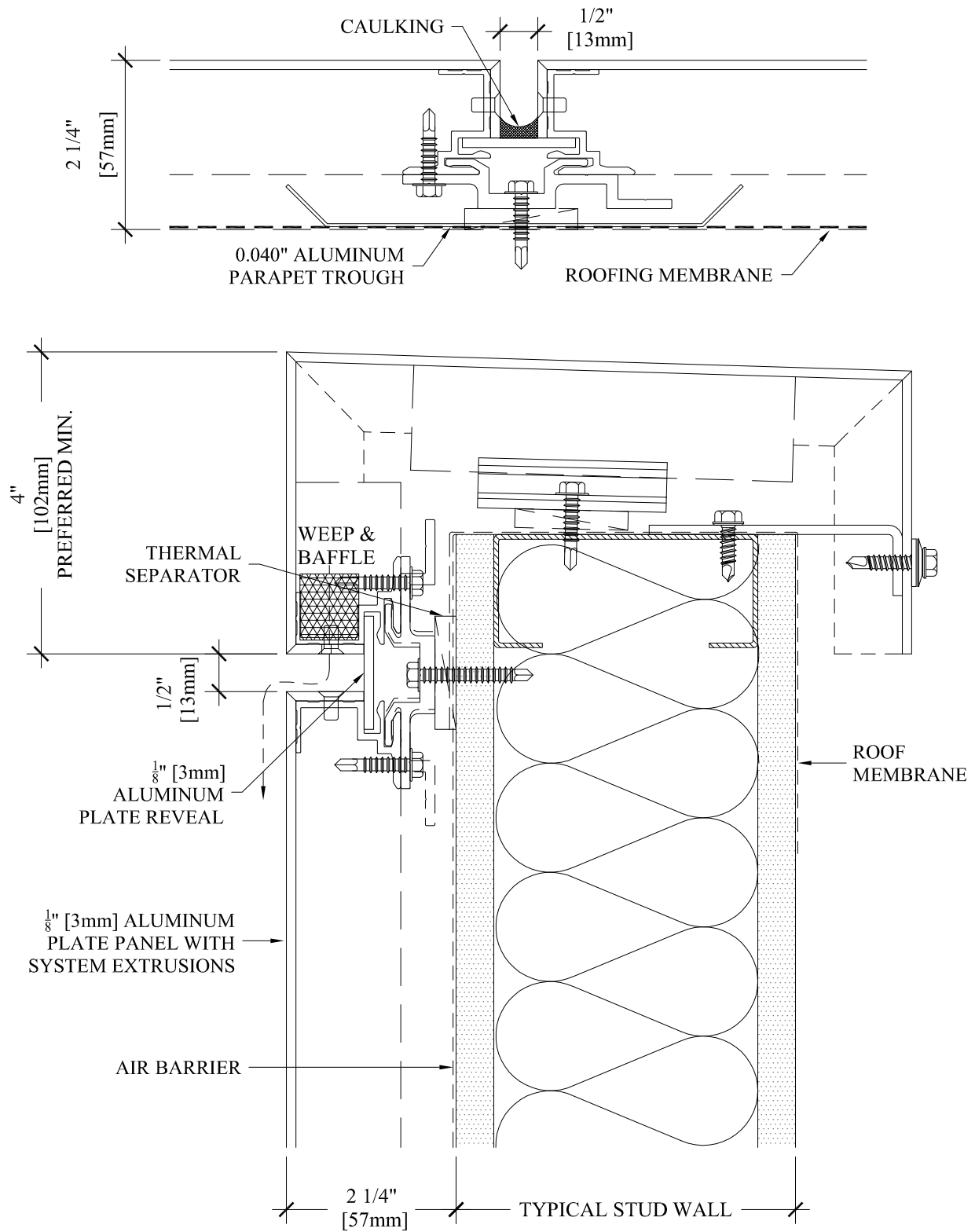

NOT TO SCALE

1 SL-2000P PARAPET DETAIL (Standard)



HAMILTON,
ONTARIO

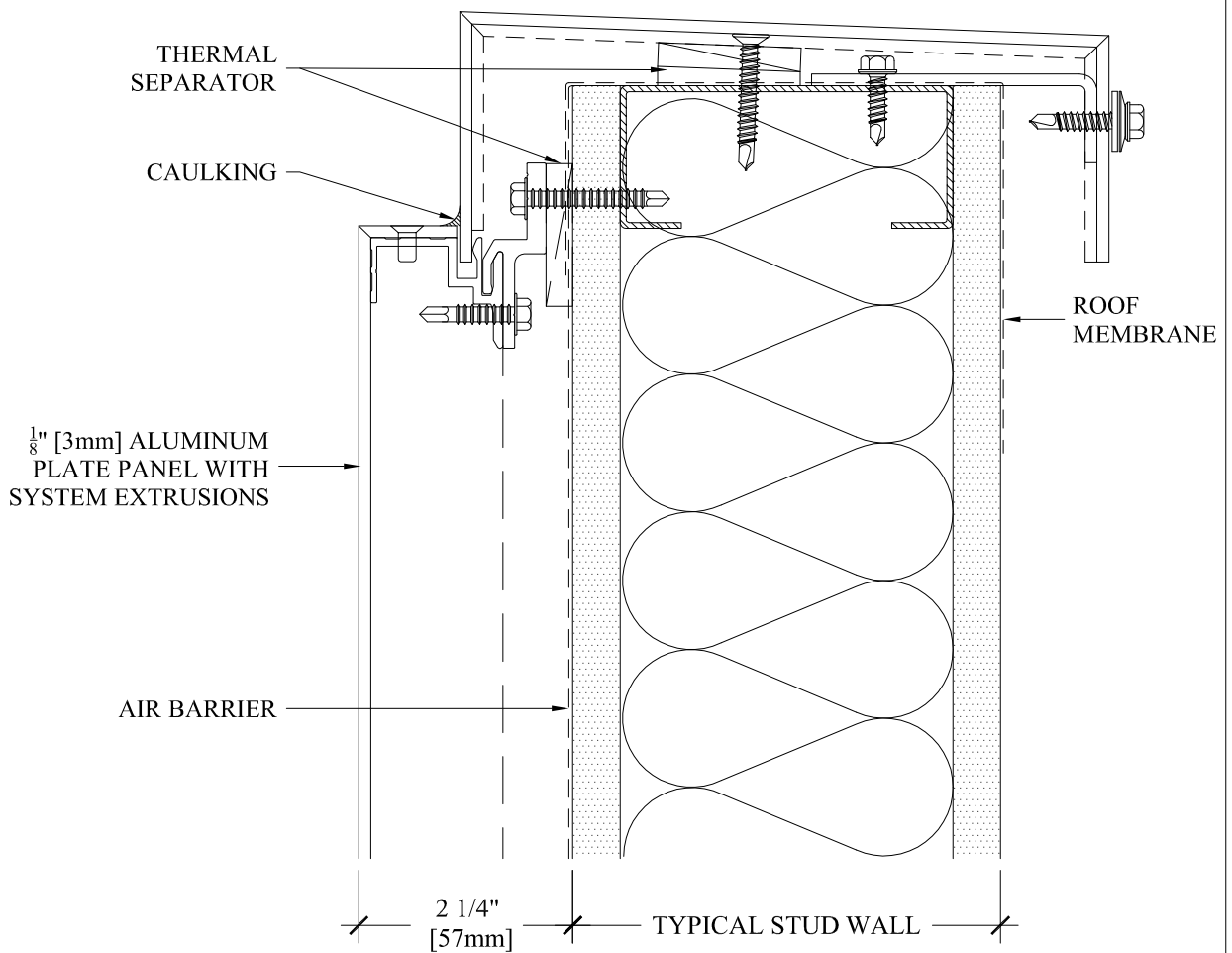
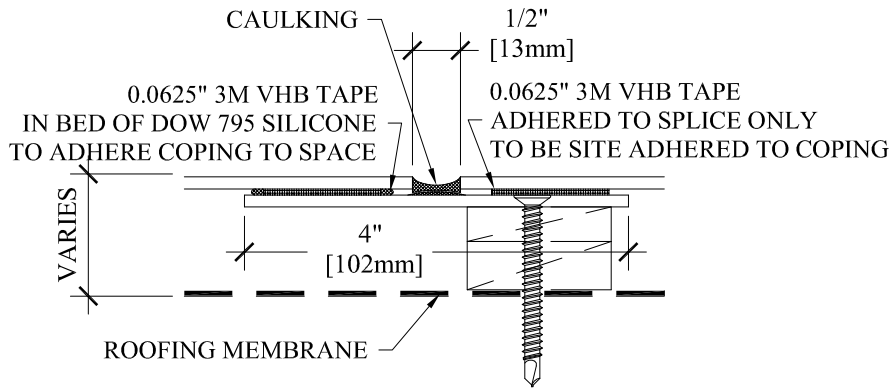

NOT TO SCALE

1A SL-2000P PARAPET DETAIL (Optional)



HAMILTON,
ONTARIO

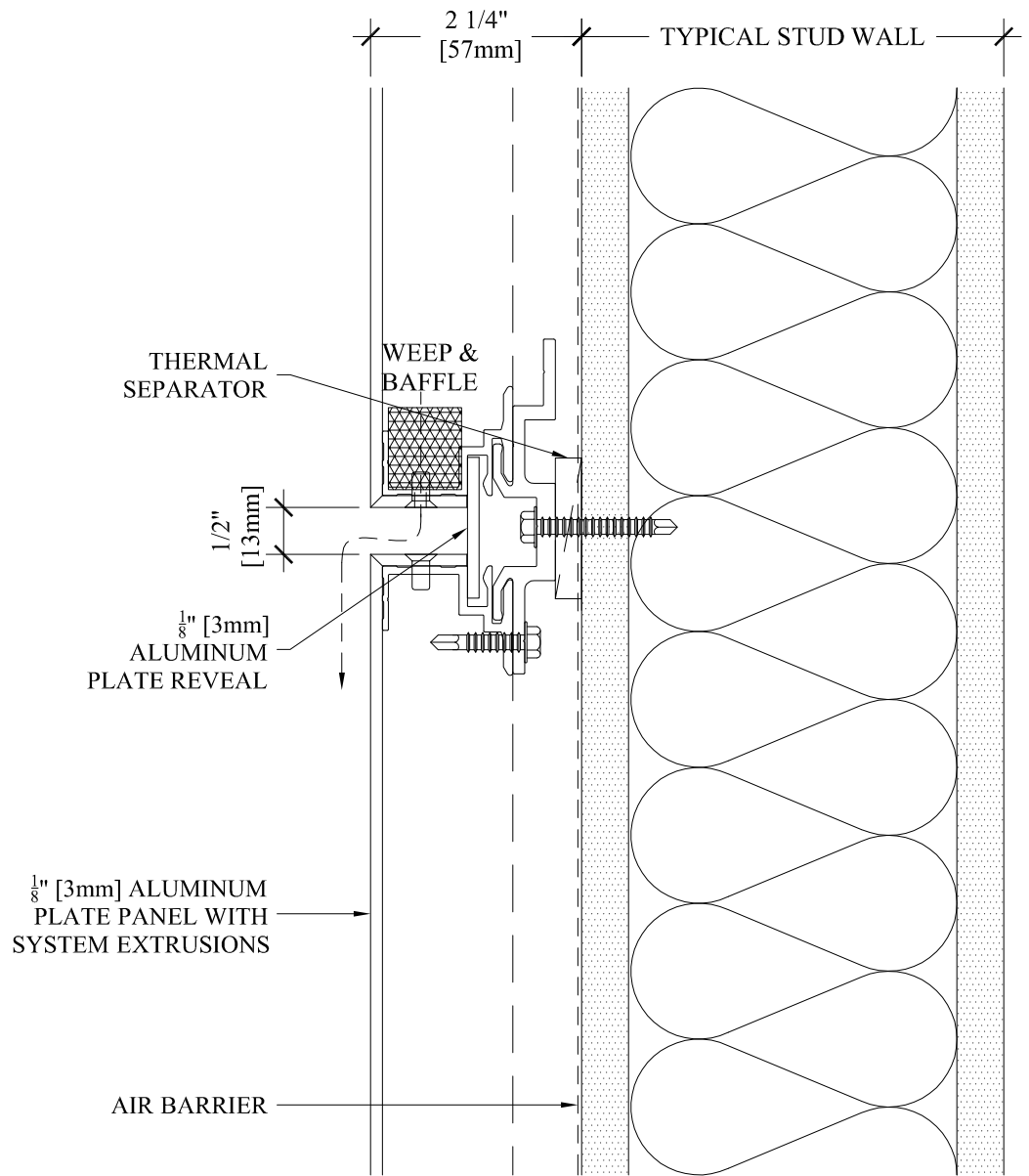

NOT TO SCALE

② SL-2000P HORIZONTAL JOINT



HAMILTON,
ONTARIO

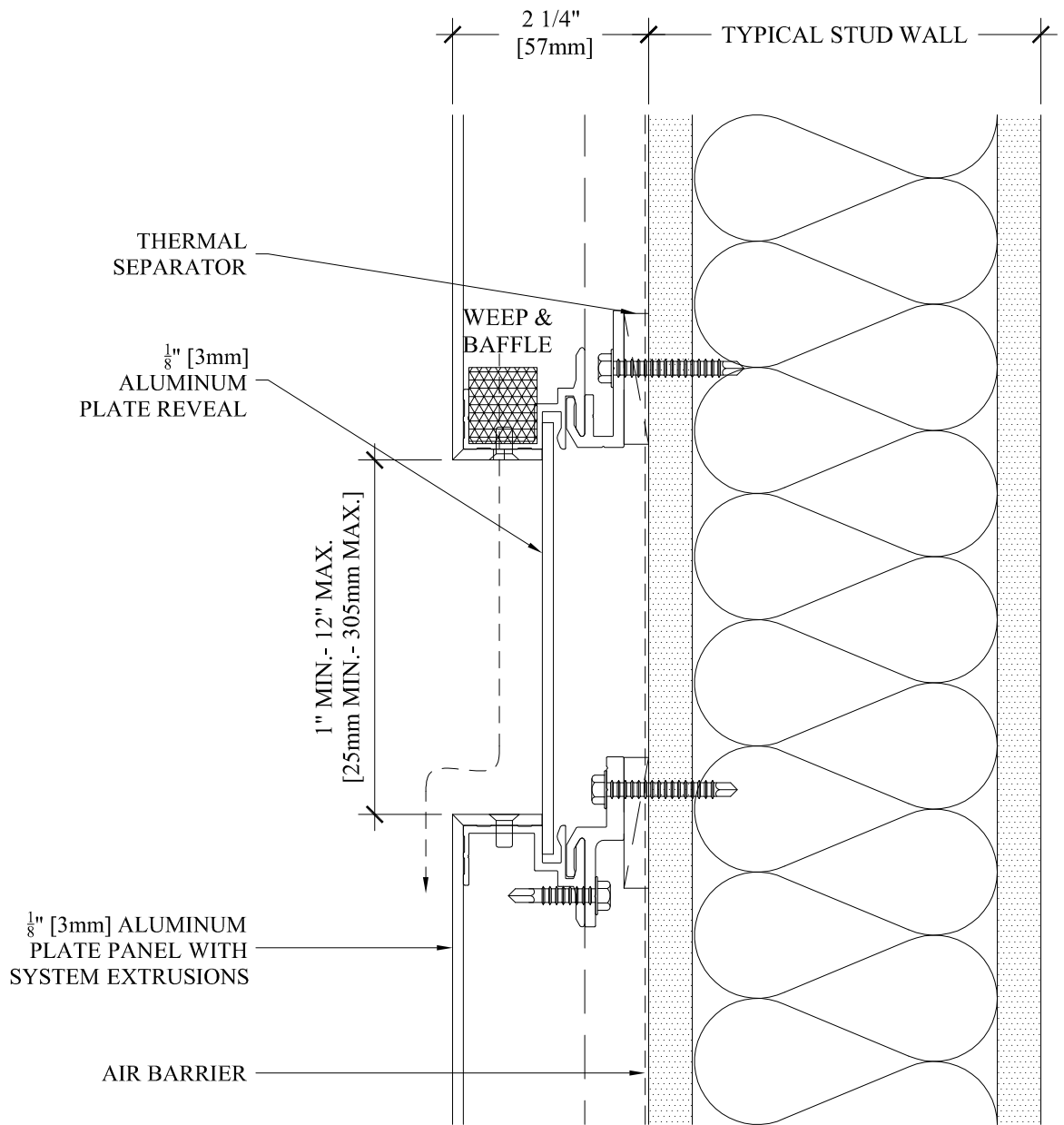

NOT TO SCALE

3 SL-2000P FEATURE BAND



HAMILTON,
ONTARIO

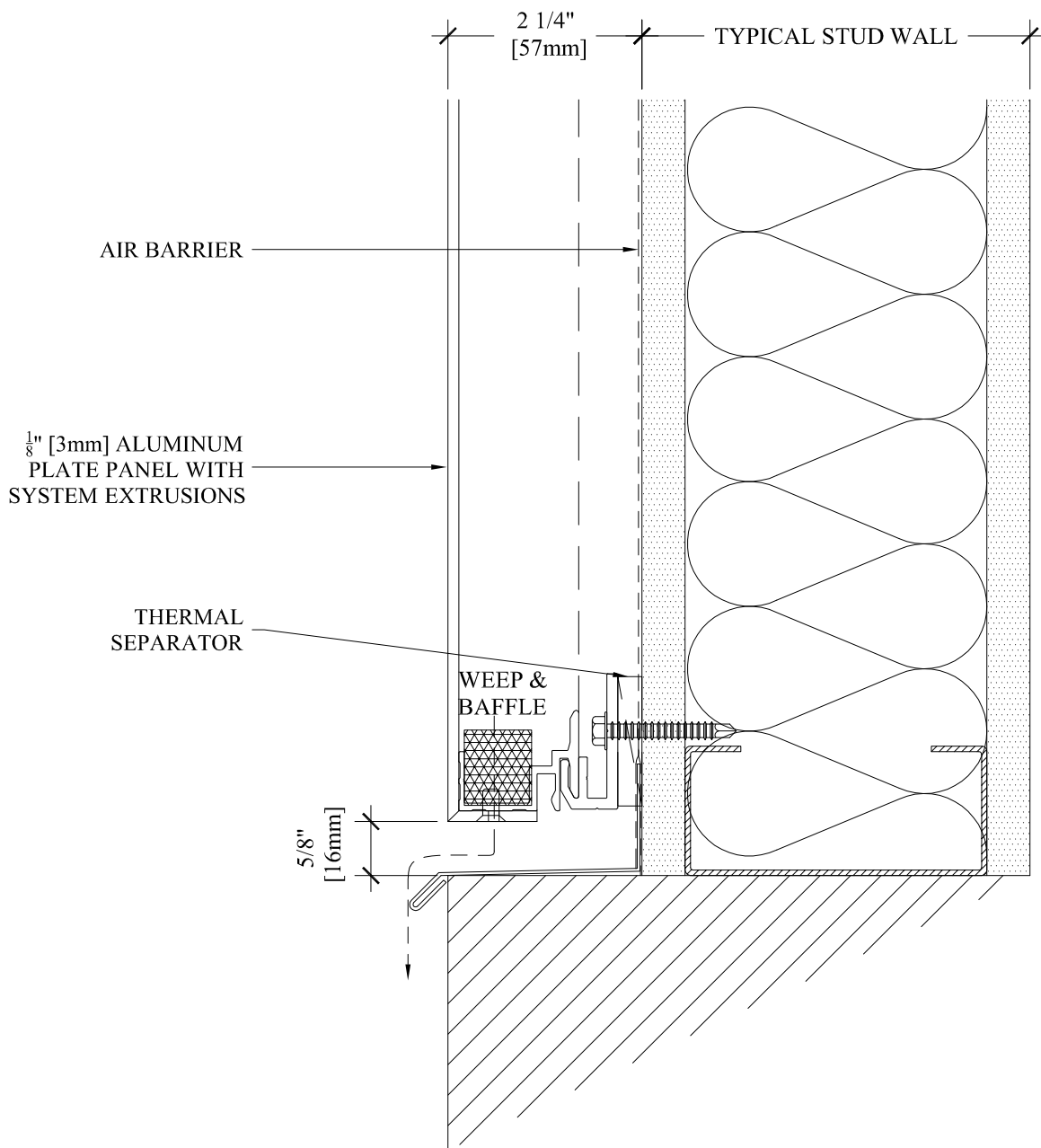

NOT TO SCALE

④ SL-2000P BASE CONDITION

SOBOTEC
 ADDING STRUCTURE TO VISION
 WWW.SOBOTEC.COM PH: 905-578-1278

HAMILTON,
 ONTARIO

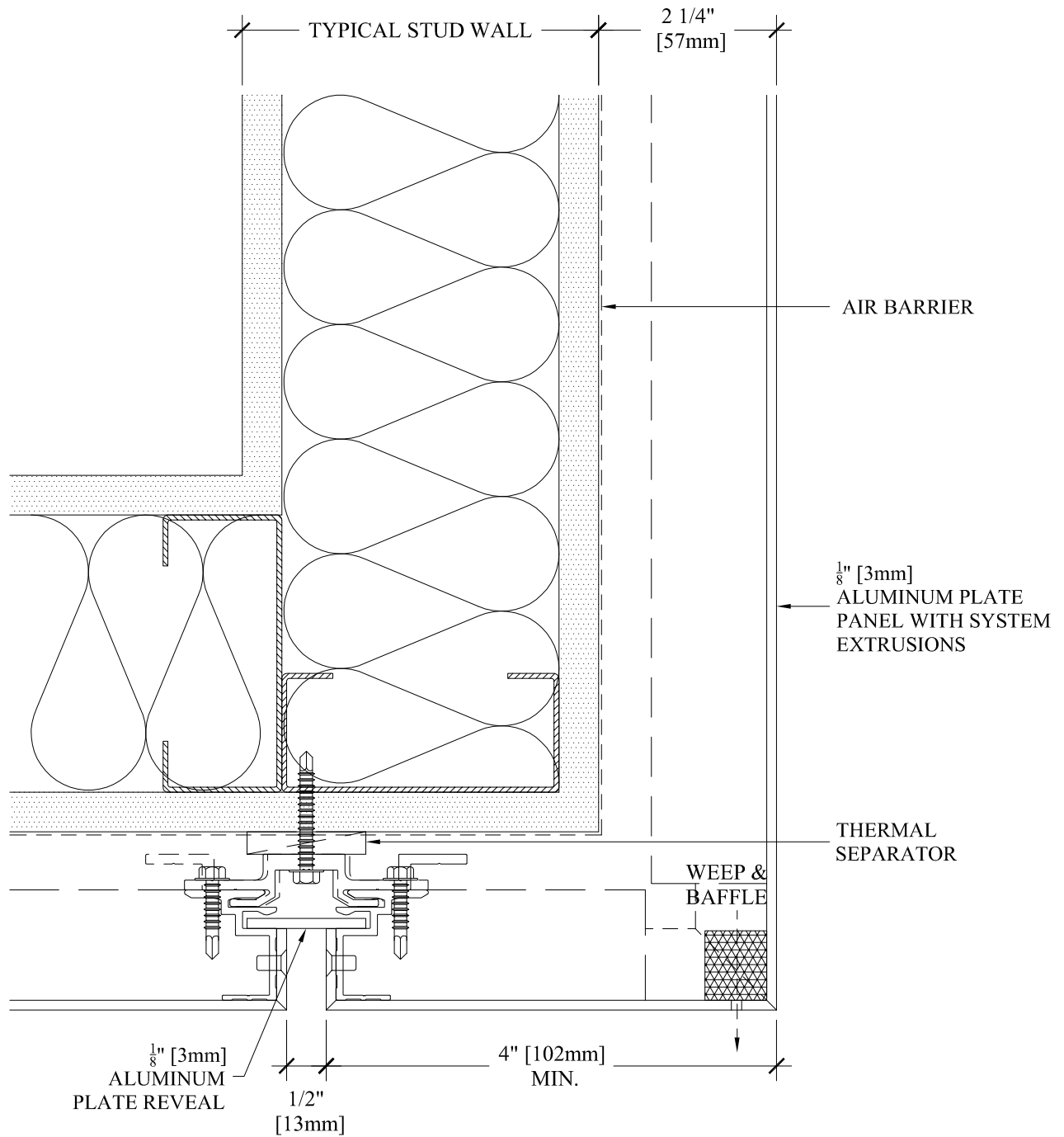

NOT TO SCALE

5 SL-2000P WALL SOFFIT DETAIL

SOBOTEC

ADDING STRUCTURE TO VISION

WWW.SOBOTEC.COM PH: 905-578-1278

HAMILTON,
ONTARIO

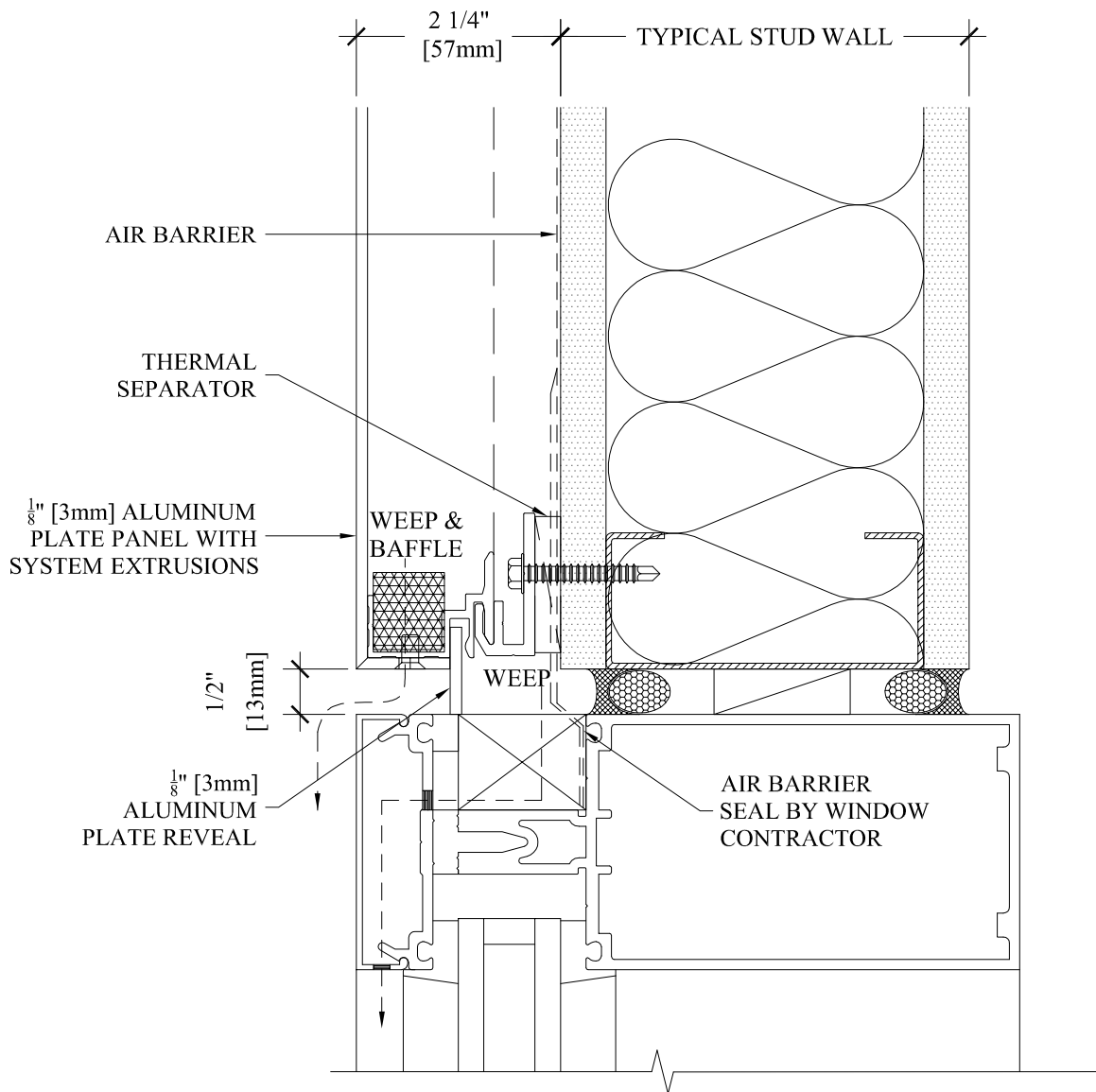

NOT TO SCALE

⑥ SL-2000P HEAD DETAIL (Standard)



HAMILTON,
ONTARIO

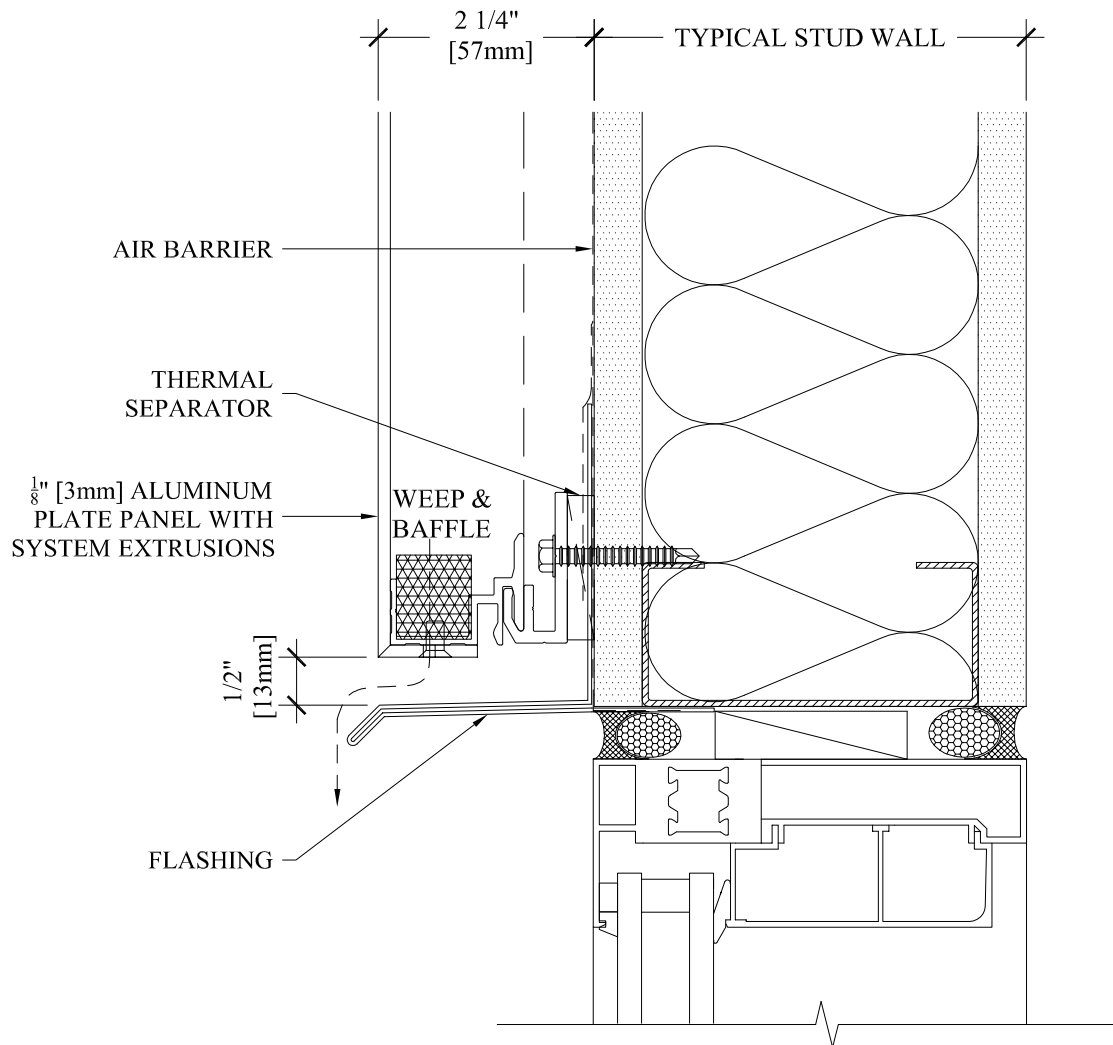

NOT TO SCALE

6A SL-2000P HEAD DETAIL (Optional)

SOBOTEC
 ADDING STRUCTURE TO VISION
 WWW.SOBOTEC.COM PH: 905-578-1278

HAMILTON,
 ONTARIO

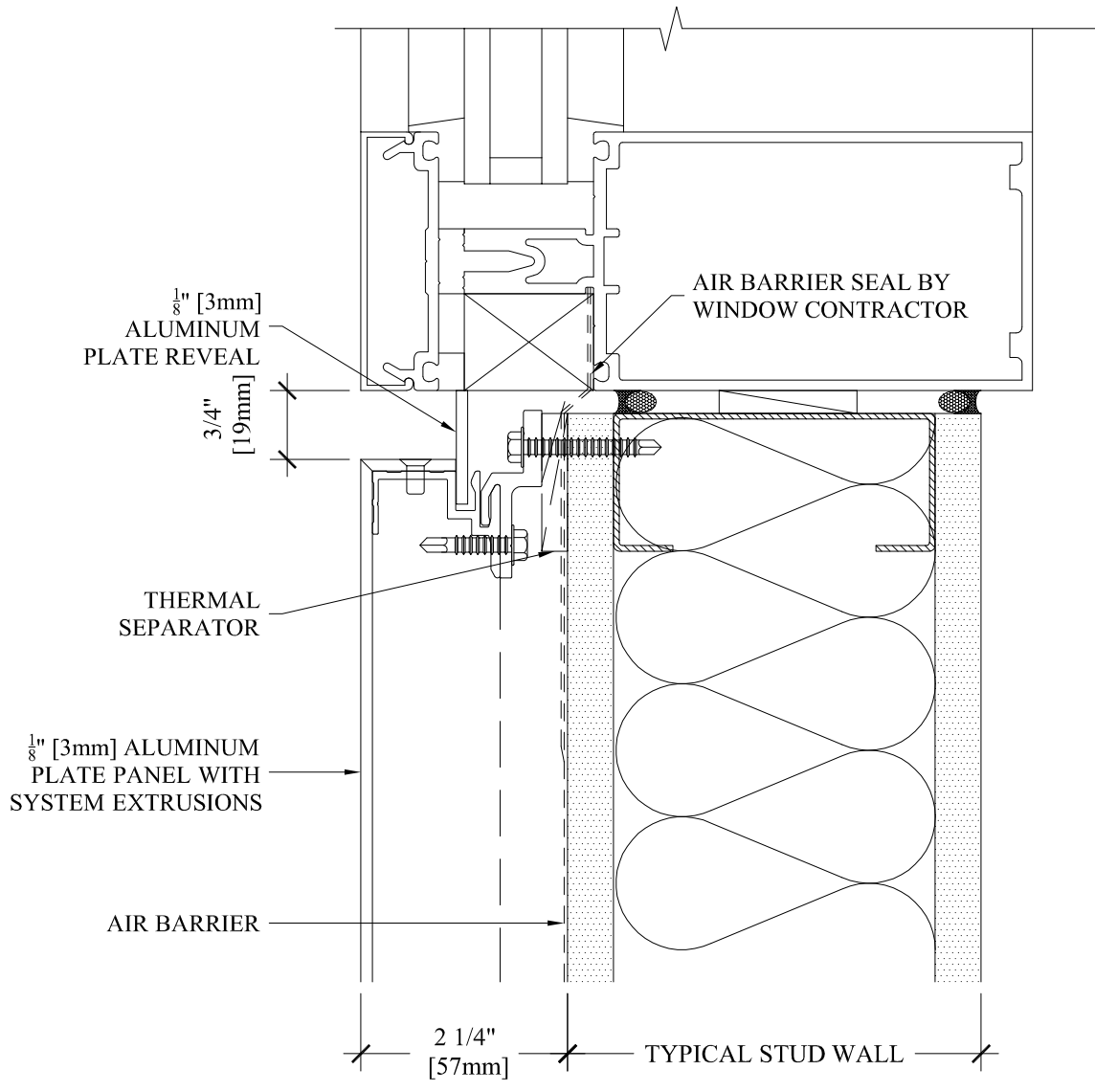

NOT TO SCALE

7 SL-2000P SILL DETAIL (Standard)



SOBOTEC
 ADDING STRUCTURE TO VISION
 WWW.SOBOTEC.COM PH: 905-578-1278

HAMILTON,
ONTARIO

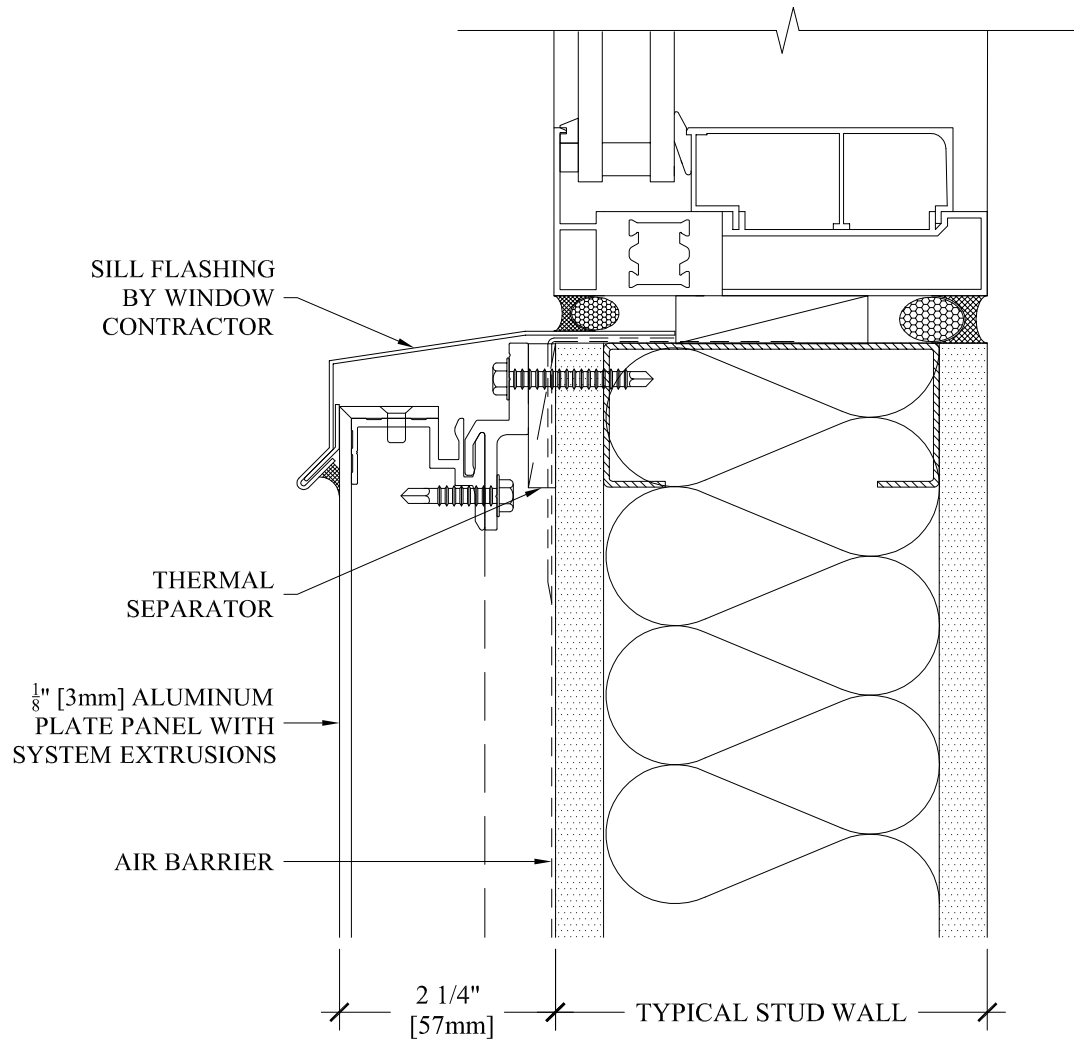

NOT TO SCALE

7A SL-2000P SILL DETAIL (Optional)



HAMILTON,
ONTARIO

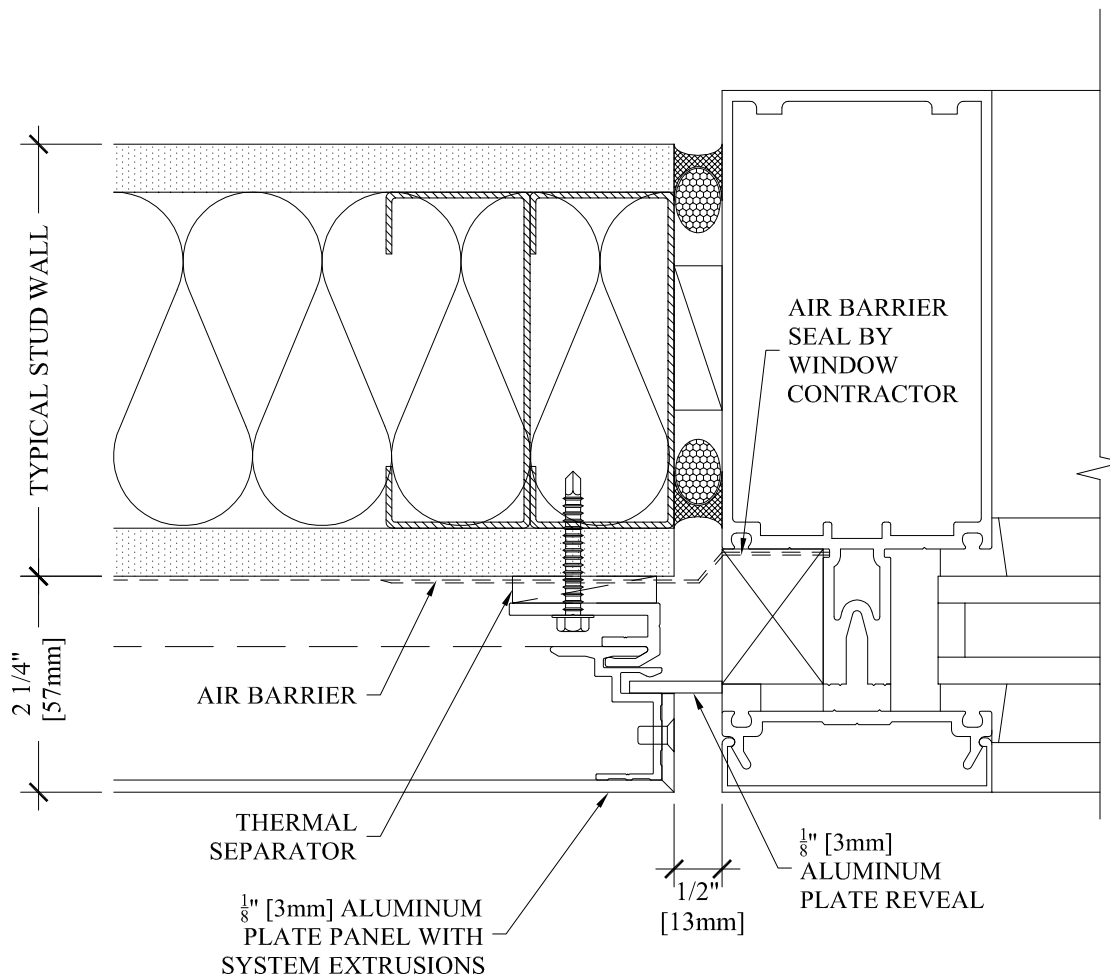

NOT TO SCALE

8 SL-2000P JAMB DETAIL (Standard)



HAMILTON,
ONTARIO

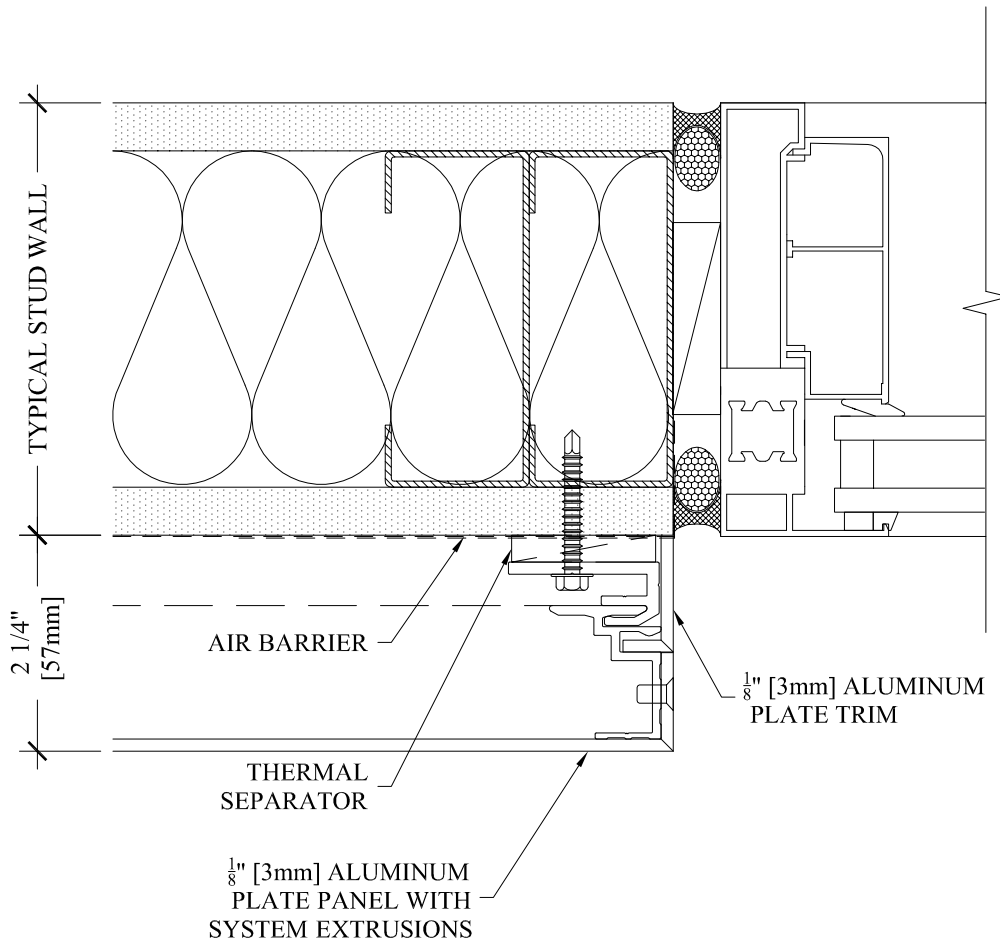

NOT TO SCALE

8A SL-2000P JAMB DETAIL (Optional)



HAMILTON,
ONTARIO

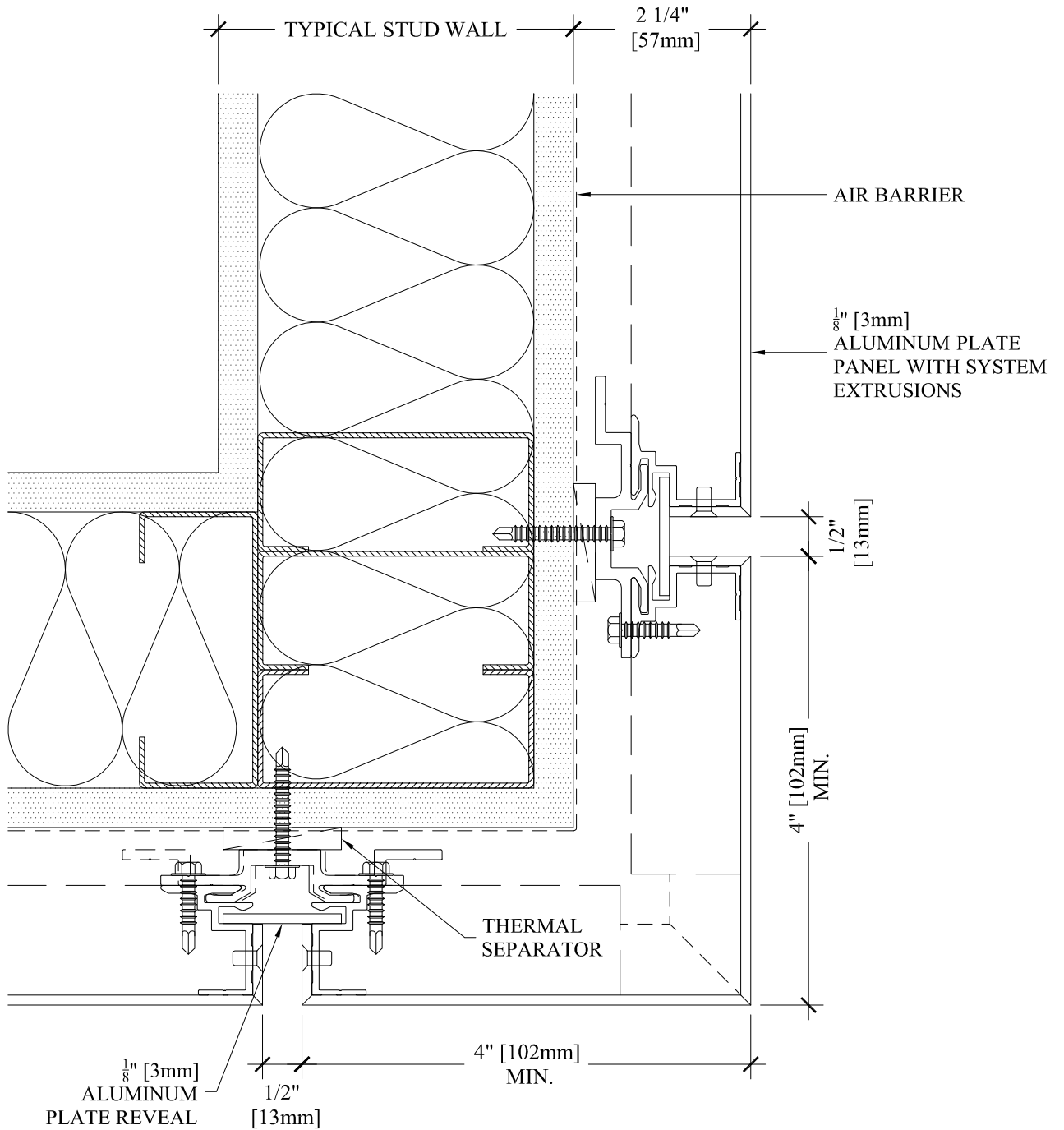

NOT TO SCALE

9 SL-2000P SQUARE OUTSIDE CORNER



HAMILTON,
ONTARIO

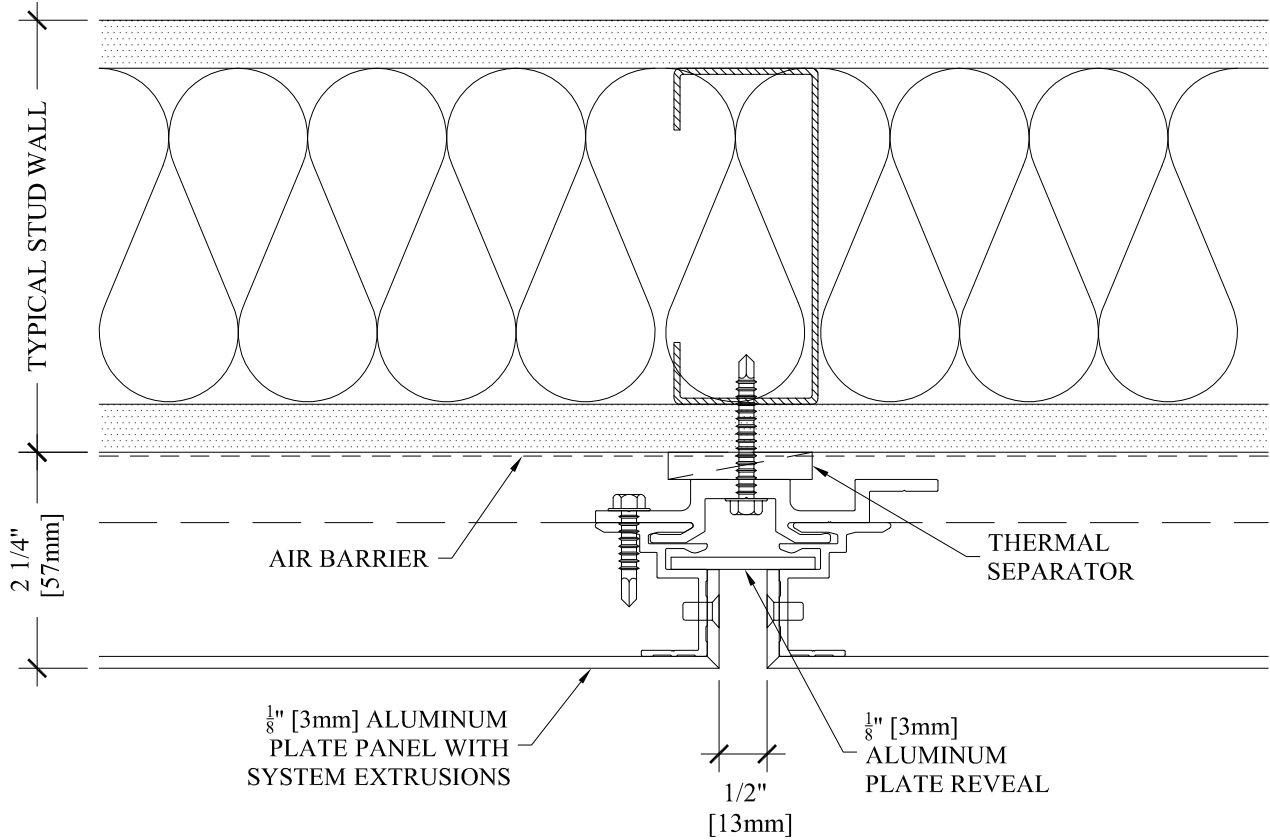

10 SL-2000P VERTICAL JOINT



HAMILTON,
ONTARIO

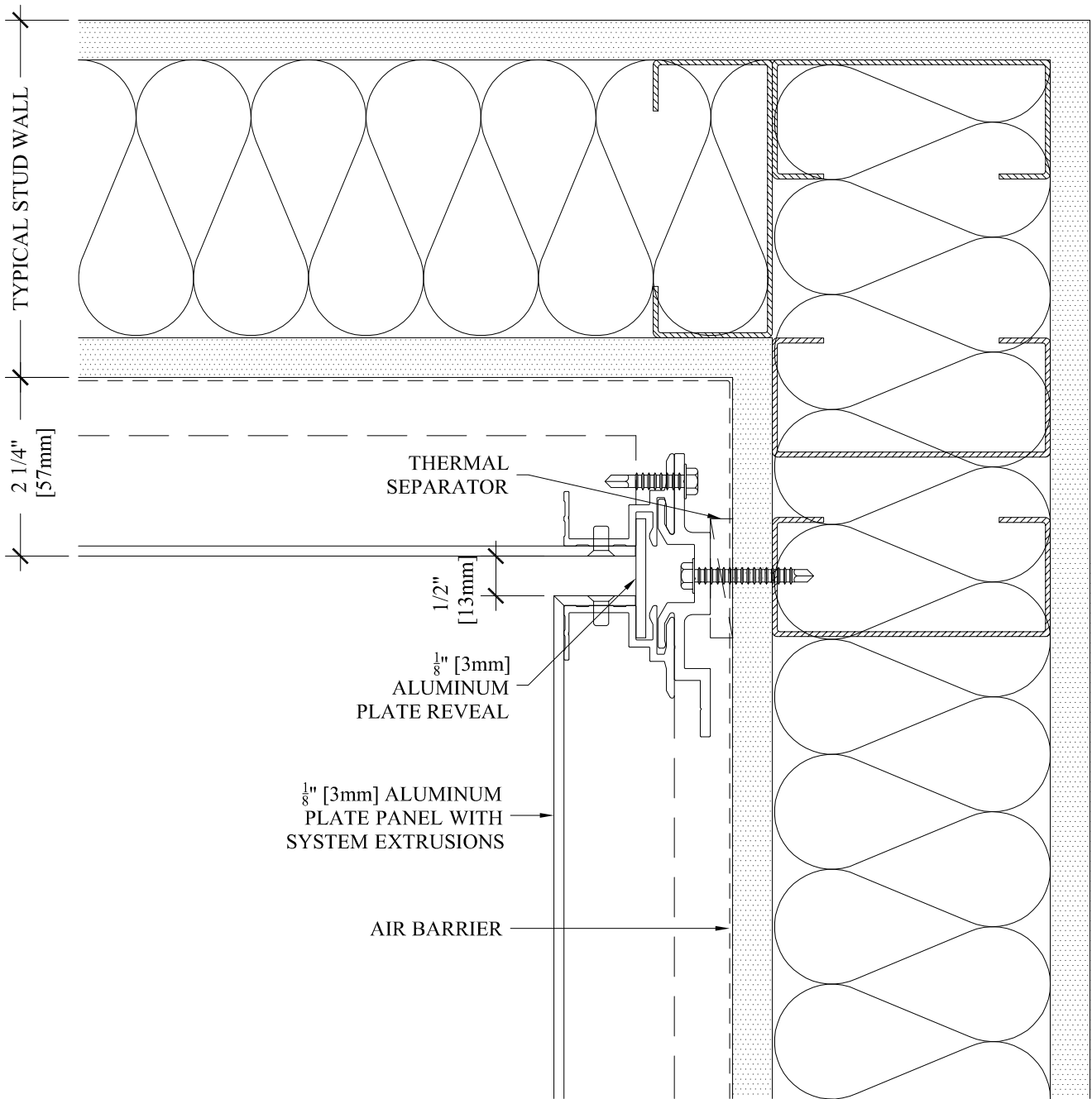

NOT TO SCALE

11 SL-2000P INSIDE CORNER



SOBOTEC
 ADDING STRUCTURE TO VISION
 WWW.SOBOTEC.COM PH: 905-578-1278

HAMILTON,
 ONTARIO

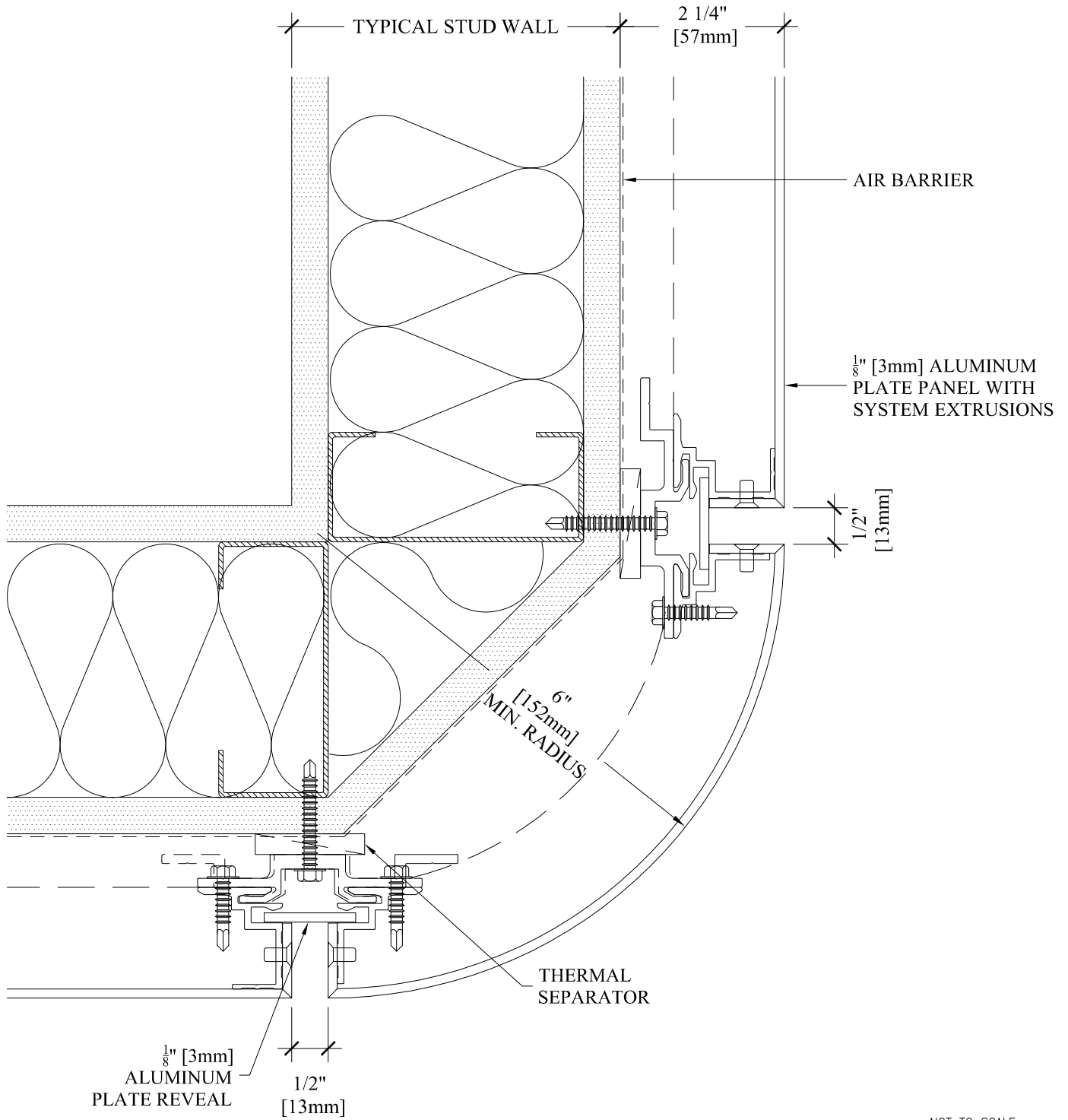

12 SL-2000P ROUND OUTSIDE CORNER



HAMILTON,
ONTARIO

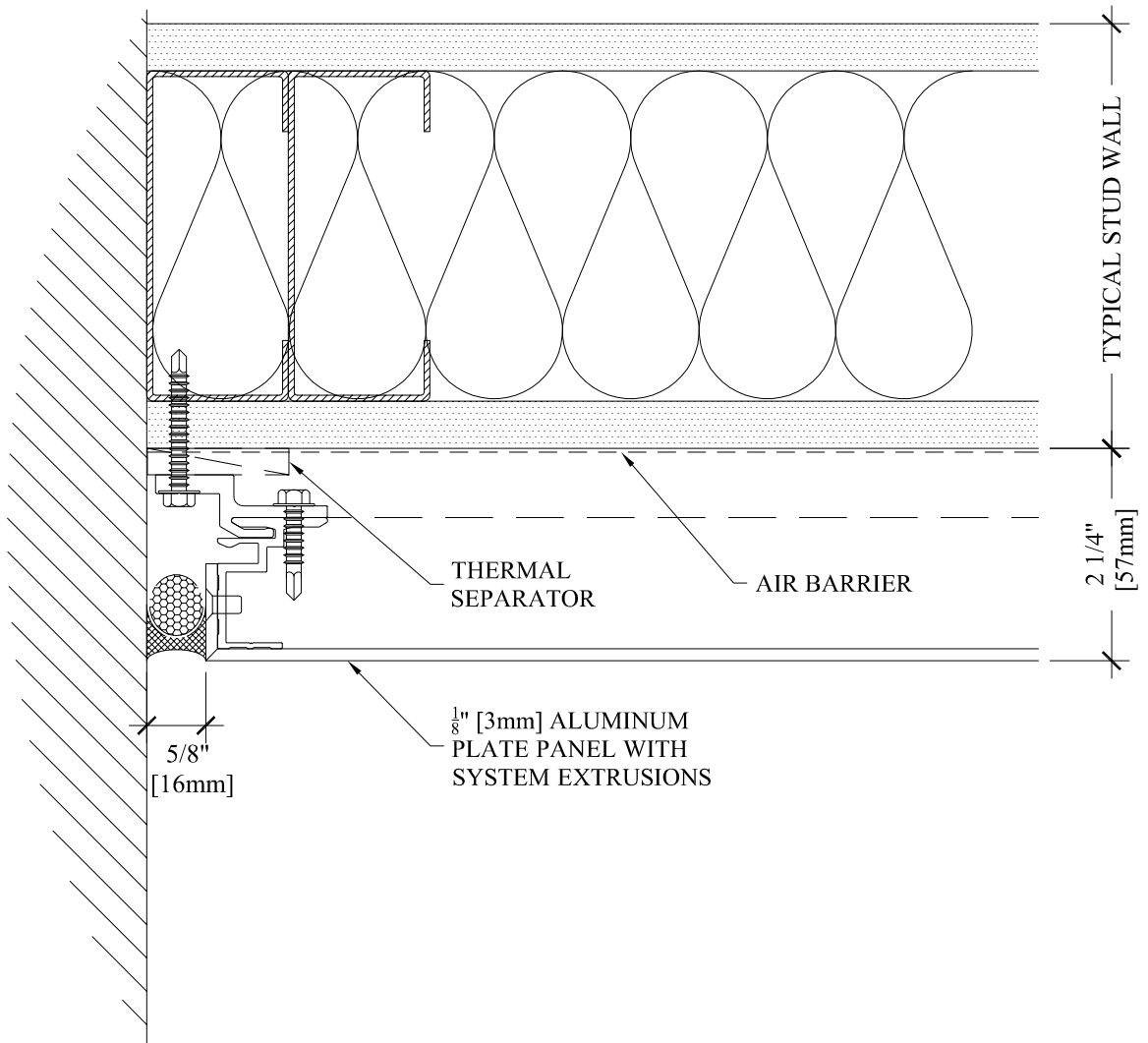

NOT TO SCALE

13 SL-2000P ABUTMENT DETAIL



HAMILTON,
ONTARIO

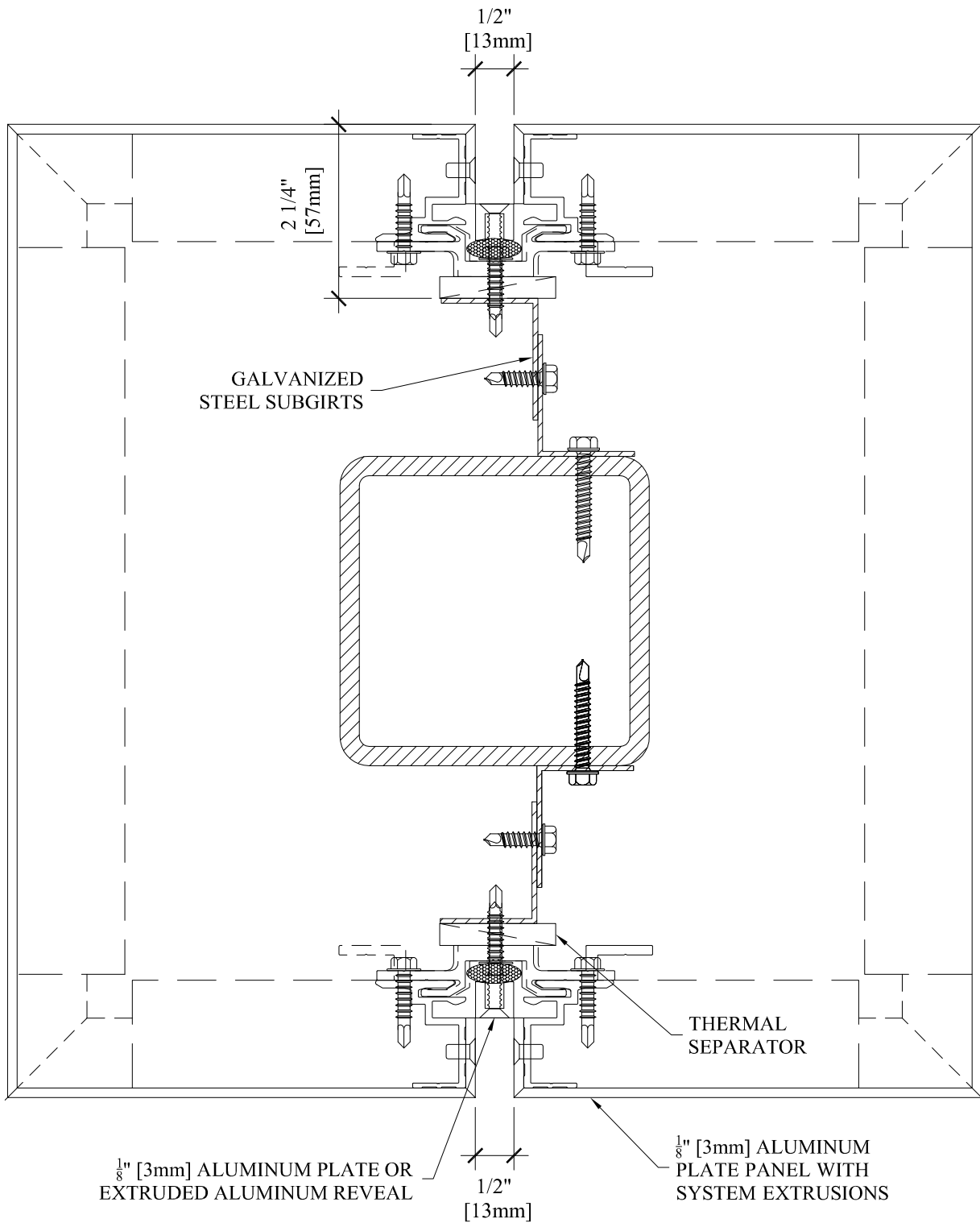

NOT TO SCALE

14 SL-2000P SQUARE COLUMN

SOBOTEC

ADDING STRUCTURE TO VISION

WWW.SOBOTEC.COM PH: 905-578-1278

HAMILTON,
ONTARIO

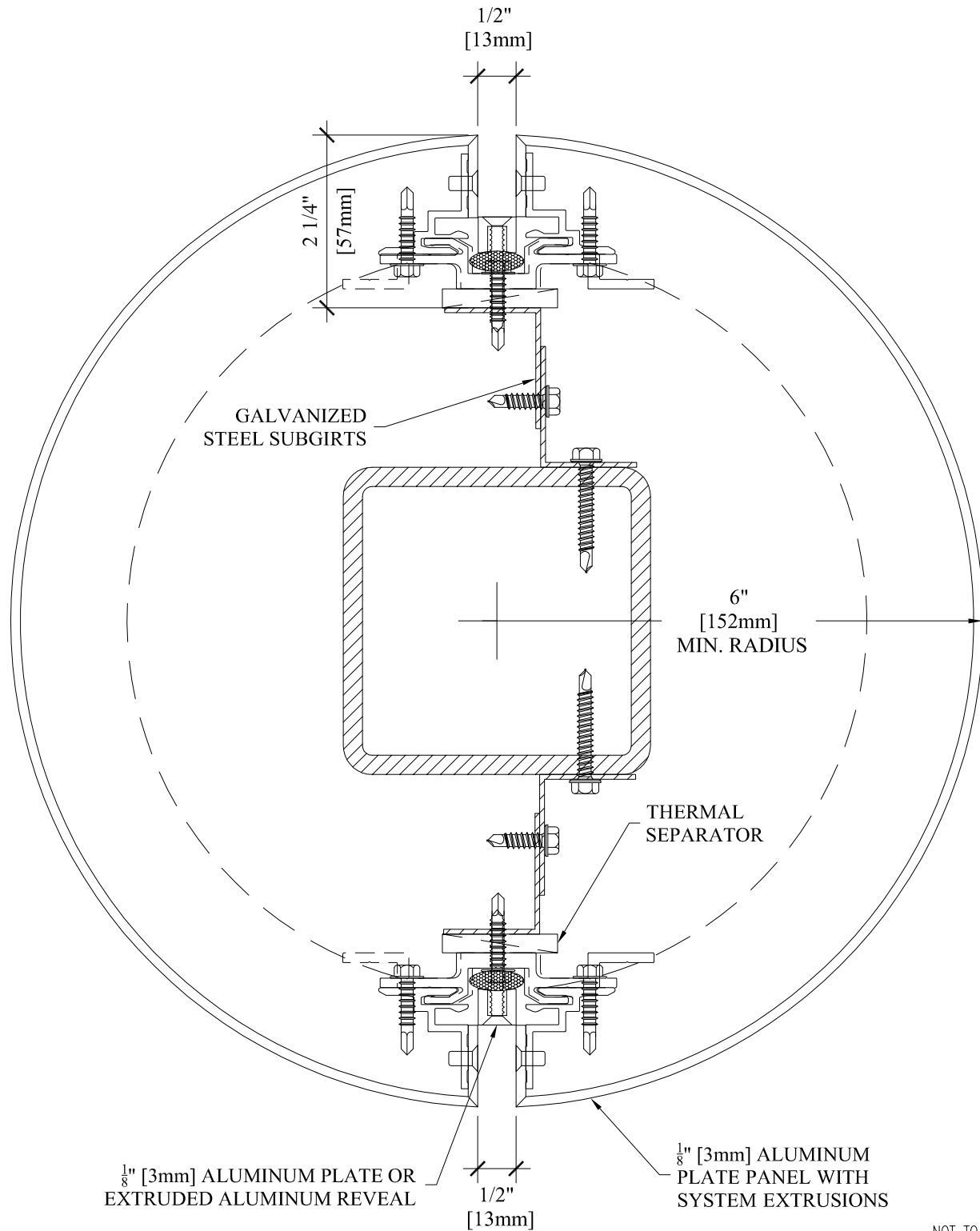

15 SL-2000P CIRCULAR COLUMN

SOBOTEC
 ADDING STRUCTURE TO VISION
 WWW.SOBOTEC.COM PH: 905-578-1278

HAMILTON,
 ONTARIO